

# Cannonball

assembly guide

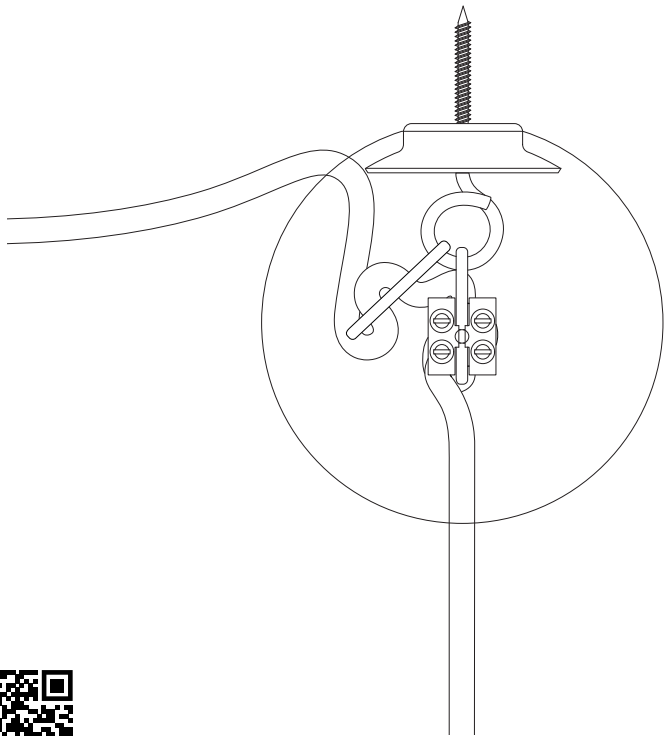

UIMAGE



Find assembly videos by using the QR code  
or by going online at our website **[umage.com/instructions](https://www.umage.com/instructions)**

## **ENGLISH - IMPORTANT**

Always shut off power to the circuit before starting installation work. In some countries electrical installation work may only be carried out by a authorised electrical contractor. Contact your local electricity authority for advice.

## **DEUTSCH - WICHTIG!**

Vor der Installation den Strom abschalten. In einigen Ländern dürfen Elektroinstallationen nur von autorisierten Elektrofachleuten ausgeführt werden. Im Zweifelsfall die örtlichen Behörden ansprechen.

## **FRANÇAIS - ATTENTION!**

Toujours couper l'alimentation au panneau principal avant de procéder à l'installation. Dans certains pays, l'installation doit être effectuée par un électricien qualifié. Pour en savoir plus, contacter les autorités locales compétentes en la matière.

## **NEDERLANDS - BELANGRIJK!**

Schakel de stroom altijd uit voordat met de installatie wordt begonnen. In sommige landen mogen elektrische installaties alleen worden uitgevoerd door een bevoegd elektricien. Neem daarom contact op met de plaatselijke overheid voor advies.

## **DANSK - VIGTIG!**

Sluk altid for strømmen, før installationen påbegyndes. I nogle lande må elektriske installationer kun udføres af en uddannet elektriker. Få oplysninger hos de relevante myndigheder.

## **ÍSLENSKA - MIKILVÆGT**

Sláíð rafmagnið úr áður en uppsetning hefst. Í sumum löndum þarf uppsetning að vera framkvæmd af löggiltum rafvirkja. Leitið ráða hjá rafvirkja varðandi uppsetninguna.

## **ČESKY - DŮLEŽITÉ**

Před instalací vždy odpojte ze sítě. V některých zemích může instalaci provést pouze kvalifikovaný elektrikář. Kontaktujte o radu nejbližšího elektrikáře.

## **ESPAÑOL - IMPORTANTE**

Desconecta siempre el interruptor general de la electricidad antes de iniciar cualquier trabajo de instalación. En algunos países, la instalación eléctrica sólo puede realizarla un electricista profesional. Ponte en contacto con las autoridades locales para saber cuál es tu caso.

## **ITALIANO - IMPORTANTE!**

Togli sempre tensione al circuito prima di iniziare l'installazione. In alcune nazioni l'installazione elettrica può essere effettuata solo da un elettricista autorizzato. Per maggiori informazioni, contatta l'autorità locale per l'energia elettrica.

## **MAGYAR - FONTOS**

Minden esetben kacsold le az áramot mielőtt elkezdted a munkát. Néhány országban elektromos installációt kizárólag szakember végezhet. Ezzel kapsolatlban érdeklődj elektromos szolgáltatódnál.

## **POLSKI - WAŻNE**

Przed rozpoczęciem instalacji odłącz zasilanie. W niektórych państwach instalacje elektryczne mogą być wykonywane wyłącznie przez wykwalifikowanych elektryków. Skontaktuj się z odpowiednimi instytucjami, aby uzyskać poradę.

## **EESTI - OLULINE**

Lülitage alati enne paigaldustööde alustamist elekter välja. Mõnes riigis võib elektritööd teostada ainult litsentseeritud elektrik. Võtke ühendust kohaliku elektriteenust pakkuva asutusega.

## **LATVIEŠU - SVARĪGI**

Pirms montāžas darbu uzsākšanas vienmēr atvienojiet galveno strāvas padevi. Dažās valstīs elektroinstalācijas darbus drīkst veikt tikai sertificēts elektrikis. Neskaitrību gadījumā sazinieties ar savu vietējo energopagādes uzņēmumu.

## **LIETUVIŲ - SVARBU!**

Prieš pradėdami elektros instaliacijos darbus, visada išjunkite elektros energiją. Kai kuriose šalyse elektros instaliacijos darbus gali atlikti tik leidimą tam turintis elektrikas. Kreipkitės į atitinkamas institucijas ir pasitikslinkite.

## **SLOVENSKY - Dôležitě**

Pred inštaláciou vždy odpojte zo siete. Zistite si, či nepatrí- te medzi tie krajiny, kde inštaláciu môže uskutočniť výlučne elektrikár. O radu požiadajte vašu lokálnu autoritu.

## **PORTUGUÊS - IMPORTANTE**

Desligue sempre a corrente eléctrica antes de começar um trabalho de instalação. Em alguns países os trabalhos de instalação eléctrica só podem ser realizados por um electricista autorizado. Contacte a sua autoridade local de electricidade para aconselhamento.

## **ROMÂNIA - ATENȚIE!**

Opriți întotdeauna alimentarea cu curent electric înainte de a începe lucrările de instalare. În unele țări, operațiunile de instalare pot fi efectuate numai de către un instalator autorizat. Pentru mai multe informații, contactați autoritatea locală care gestionează energia electrică.

## **HRVATSKI - VAŽNO**

Uvijek isključite struju prije instalacije. U nekim zemljama postavljanje električnih instalacija može obavljati samo ovlašten električar. Za savjet kontaktirajte svog lokalnog ovlaštenog električara.

## **ΕΛΛΗΝΙΚΑ- ΣΗΜΑΝΤΙΚΟ**

Πριν από την έναρξη της εργασίας εγκατάστασης, να διακόπτετε πάντα την παροχή ρεύματος από τον γενικό διακόπτη. Σε μερικές χώρες, οι ηλεκτρολογικές εργασίες θα πρέπει να πραγματοποιούνται μόνο από ένα εξουσιοδοτημένο ηλεκτρολόγο. Για πληροφορίες, επικοινωνήστε με την εταιρία ηλεκτρισμού της περιοχής σας.

## **SRPSKI - BITNO!**

Uvek isključite struju pre nego što počnete s intaliranjem. U pojedinim državama elektro-instalacije mogu da postave samo osobe s ovlašćenjem. Obratite se lokalnoj elektro-distribuciji za savet.

## **РУССКИЙ - ВНИМАНИЕ**

Перед установкой всегда отключайте электропитание. В некоторых странах электроустановка должна производиться только квалифицированным электриком. Обратитесь за консультацией в соответствующие местные инстанции.

## **SLOVENŠČINA - POMEMBNO**

Pred začetkom dela vedno izklopite električno napajanje. V nekaterih državah sme električno napeljavno napeljevati le pooblašteni električar. Za nasvet se obrnite na najbližji pooblašteni servis.

## **БЪЛГАРСКИ - ВАЖНО!**

Винаги изключвайте електрозахранването във веригата, преди да извършвате работа по инсталацията. В някои страни работа по електрическите инсталации може да се извършва единствено от оторизиран електротехник. За препоръка се обърнете към местната електрическа компания.

## **TÜRKE - ÖNEMLİ!**

Kuruluma başlamadan önce her zaman elektrik devresini kapatınız. Bazı ülkelerde elektrik kurulum işlemi sadece yetkili elektrik teknikerleri tarafından yapılmaktadır. Size en yakın yerel elektrik idaresi ile temas kurarak bu konuda bilgi alabilirsiniz.

## **中文 - 重要事項**

安裝工作开始前，请务必切断电路电源。在一些国家，电气安装必须由有资质的电力承包商完成。请联系您当地的电力部门，征询建议。

## **繁中 - 重要訊息**

安裝前請務必關掉電源。有些國家的電力安裝工作需由有執照的專業電工執行，如有任何疑問，請聯絡專業人員。

## **한국어 - 중요!**

설치작업을 시작하기 전 반드시 회로의 전원을 차단하세요. 일부 국가에 서는 공인전기시공업체만 전기 공사를 진행할 수 있습니다. 관련 정보는 지역 전력 관할 기관에 문의하세요.

## **日本語 - 重要**

設置作業を開始する前に必ずブレーカーを切ってください。電気工事の作業を行うには、資格を必要とする国もあります。お近くの電気工事店にご相談ください。

## **BAHASA INDONESIA**

### **PENTING!**

Selalu matikan listrik ke sirkuit sebelum memulai pekerjaan pemasangan. Di beberapa negara pekerjaan pemasangan listrik hanya boleh dilakukan oleh tukang listrik tersertifikasi. Hubungi tukang listrik berwenang di tempat anda untuk saran.

## **BAHASA MALAYSIA**

### **PENTING**

Sentiasa padamkan bekalan kuasa ke litar sebelum memulakan kerja-kerja pemasangan. Di beberapa negara kerja-kerja pemasangan elektrik hanya boleh dilakukan oleh kontraktor elektrik yang bertauliah. Hubungi pihak berkuasa tempatan untuk mendapatkan nasihat tentang bekalan elektrik.



**ENGLISH**

Max 2 kg/4 lb

**DEUTSCH**

Max. 2 kg

**FRANÇAIS**

Max 2 kg

**NEDERLANDS**

Max. 2 kg.

**DANSK**

Maks. 2 kg.

**ÍSLENSKA**

Hámarksþyngd 2 kg/4 pund

**NORSK**

Maks. 2 kg

**SUOMI**

Max 2 kg

**SVENSKA**

Max. 2 kg

**ČESKY**

Max 2 kg/4 lb

**ESPAÑOL**

Máx. 2 kg.

**ITALIANO**

Max. kg 2.

**MAGYAR**

Max 2 kg/ 4 lb

**POLSKI**

Maks. 2 kg/4 lb

**EESTI**

Max 2 kg

**LATVIEŠU**

Maksimālā slodze: 2 kg

**LIETUVIŲ**

Nedaugiau 2 kg

**PORTUGUÊS**

Máx 2kg/4 lb.

**ROMÂNĂ**

Greutate maximă: 2 kg.

**SLOVENSKY**

Max 2 kg/4 lb

**БЪЛГАРСКИ**

Макс. 2 кг

**HRVATSKI**

Maks. 2 kg

**ΕΛΛΗΝΙΚΑ**

Μέγιστο βάρος 2 kg

**РУССКИЙ**

Макс 2 кг/4 фунта

**SRPSKI**

Najviše: 2kg/4lb

**SLOVENŠČINA**

Največ 2 kg

**TÜRKÇE**

Maks. 2 kg/4 lb.

**中文**

最大承重 2 公斤

**繁体中**

最高可載重2公斤

**한국어**

최대 2kg/4lb

**日本語**

最大 2 kg

**BAHASA INDONESIA**

Maks 2 kg/4 lb

**BAHASA MALAYSIA**

Maksimum 2 kg/4 paun

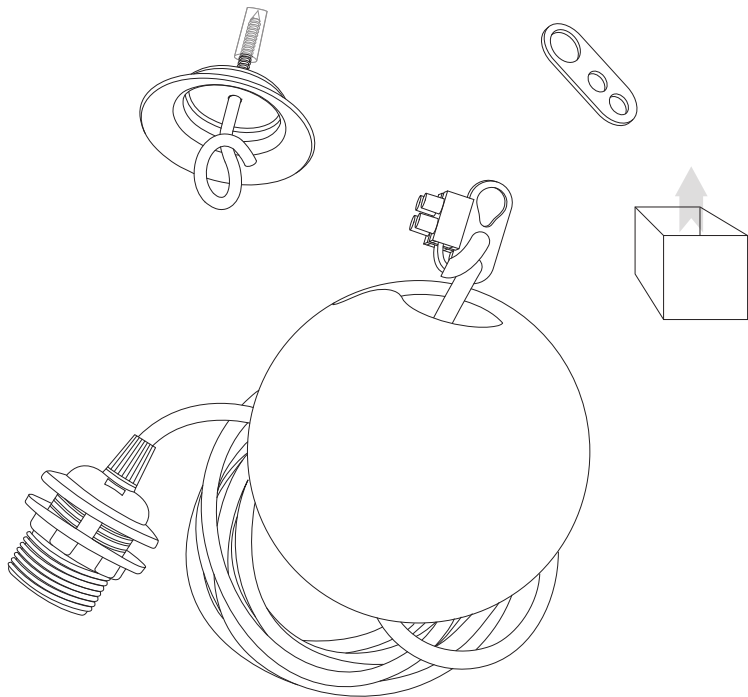



1

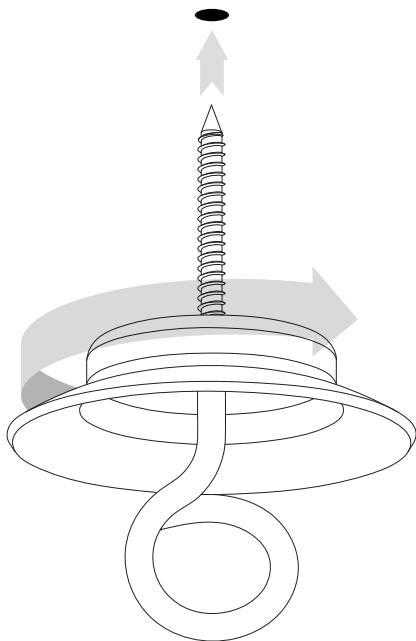
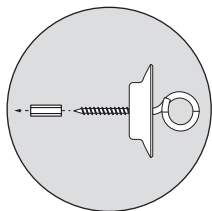

2

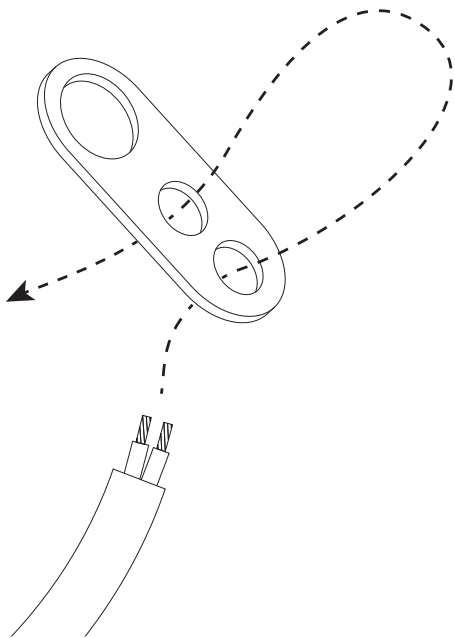

3

**IMPORTANT!**  
with Acorn, Ripples, Clava & Clava Dine go to 3B

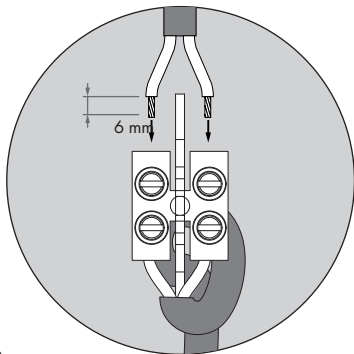
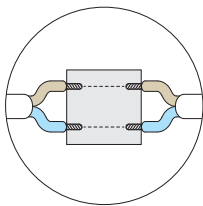

4

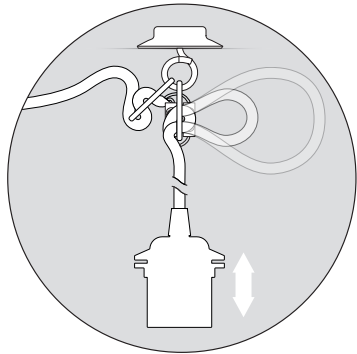
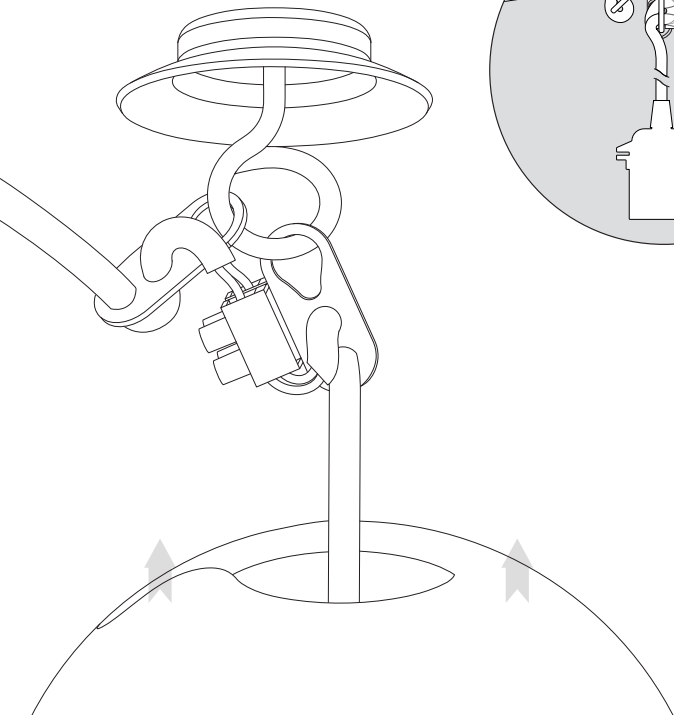

5

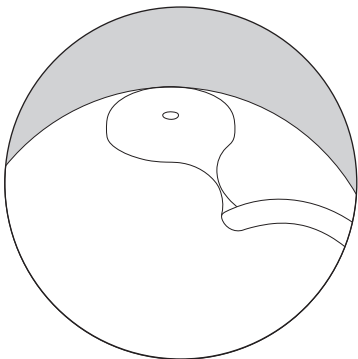
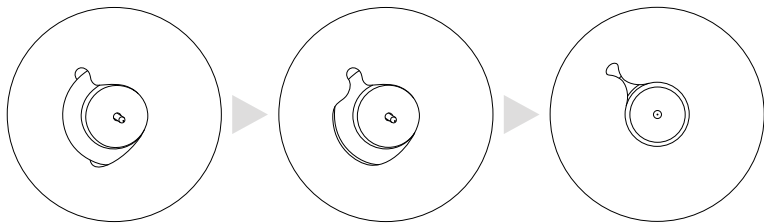

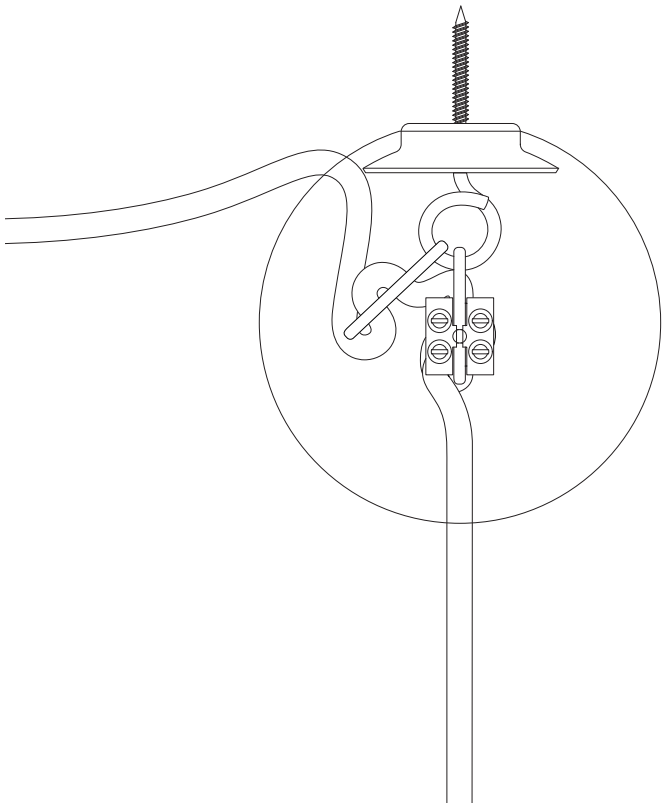

3B

**IMPORTANT!**  
only with Acorn, Ripples, Clava & Clava Dine

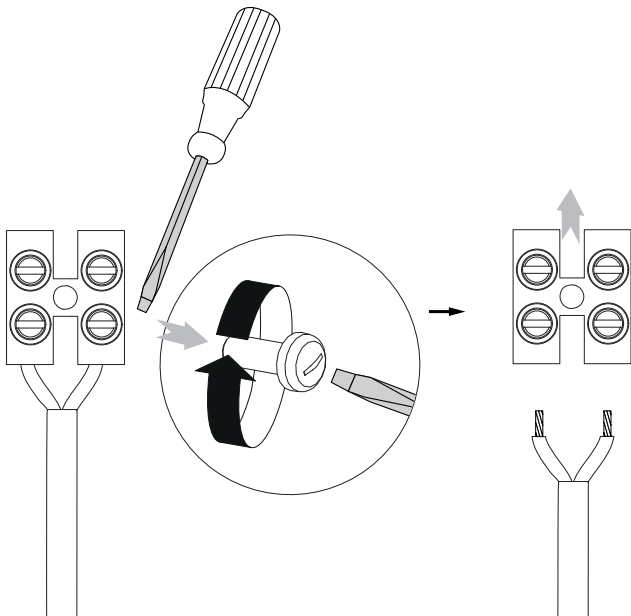

4B

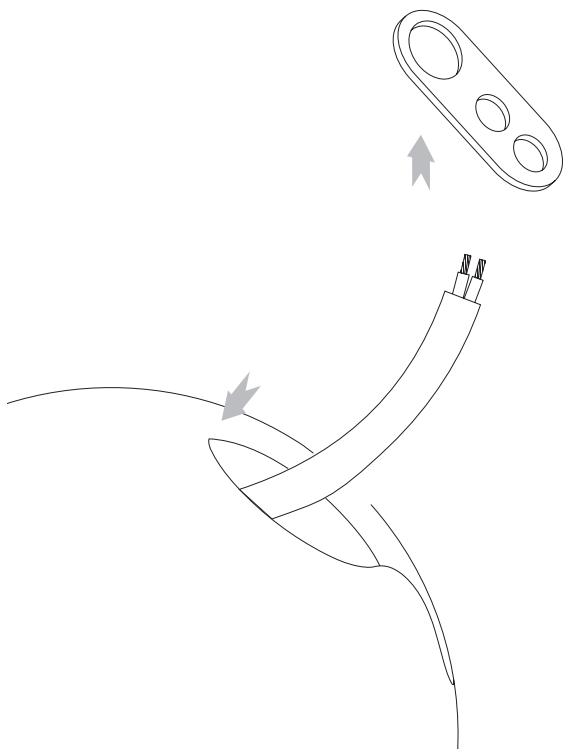



5B

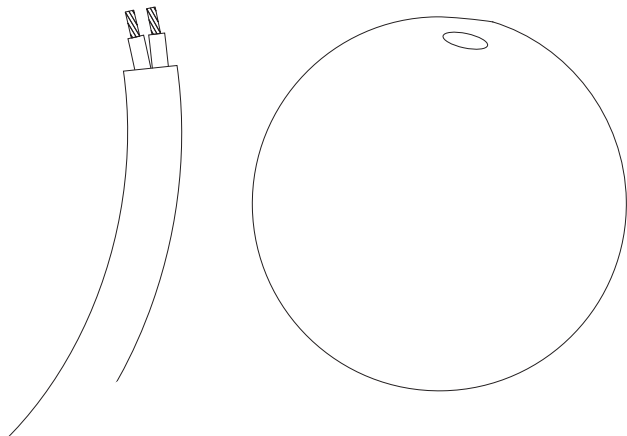

6B Acorn

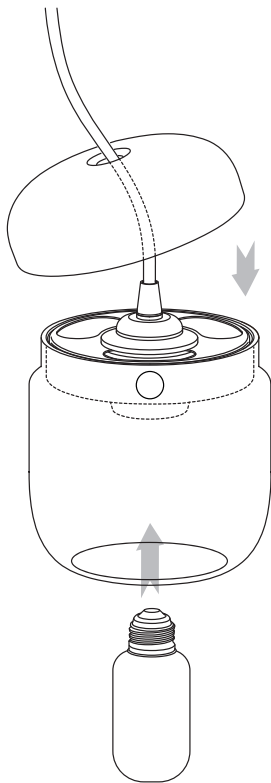
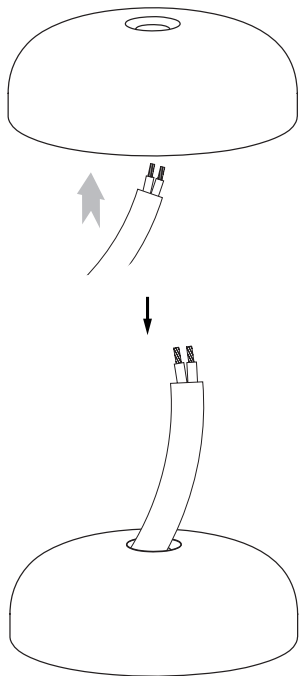

6B Ripples

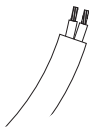
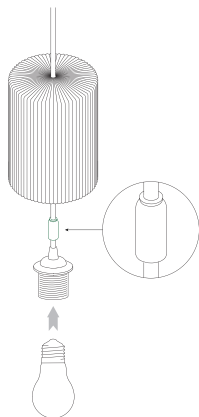
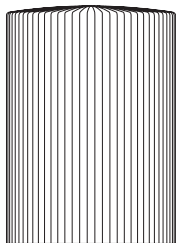
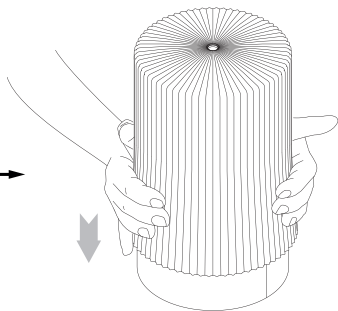
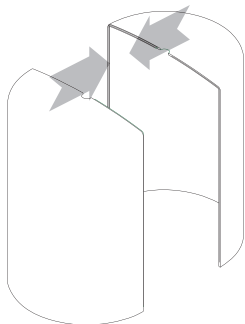

6B Clava & Clava Dine

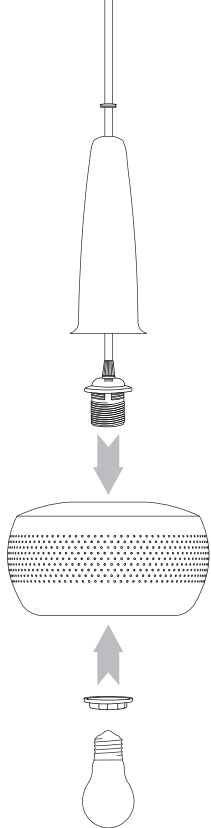
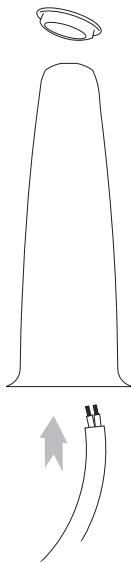

6B

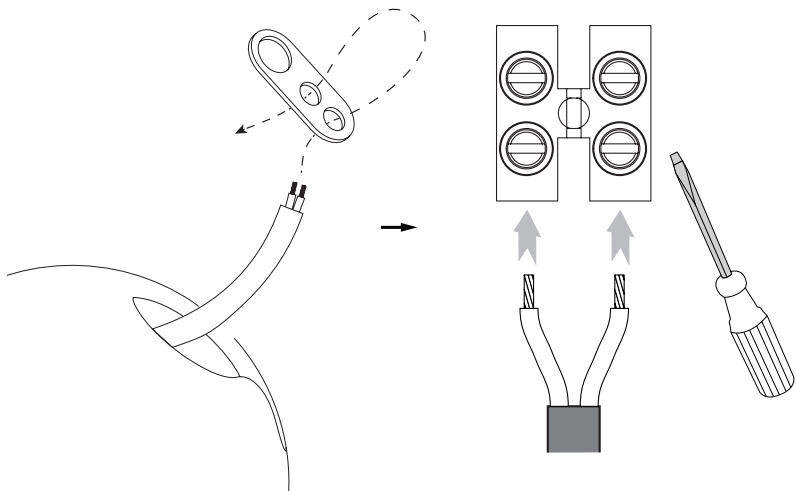

**GOTO**

3

Acorn white



Sine felt grey



Willow single





Silvia white | medium

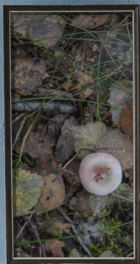

Eos light grey | large



UMAGE  
UNFOLD  
AT HOME

GET THE **FREE UIMAGE APP**  
Preview our entire collection in  
your own home – *before you buy*

Imagine a UIMAGE lamp or furniture piece in your home. Is it the right design, size and colour? We made it easier for you to find the perfect UIMAGE design. Just download our free **UMAGE Unfold at Home** app from the App Store or Play Store, and see how our designs will look in your home!



  
UMAGE

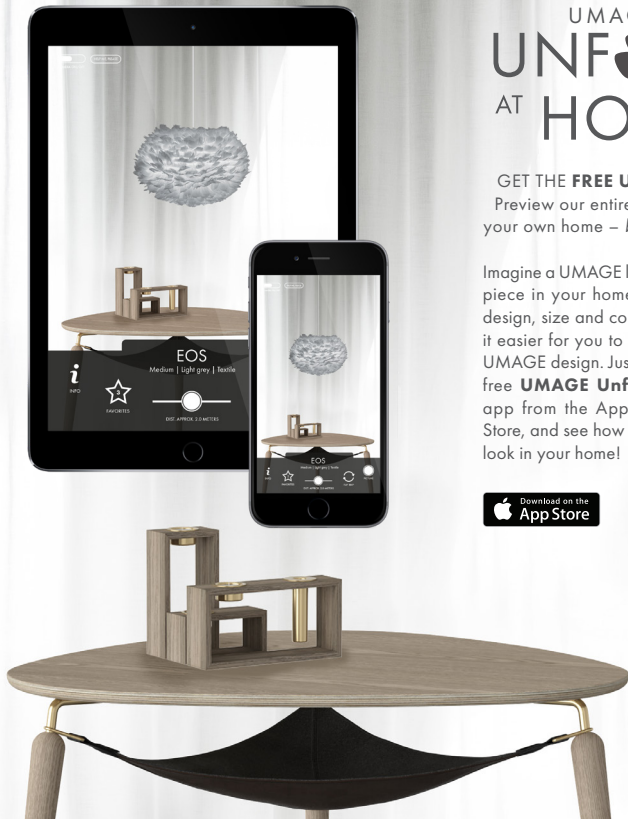

FOLLOW US ON SOCIAL MEDIA



@umagedesign



UIMAGE  
umage.com