

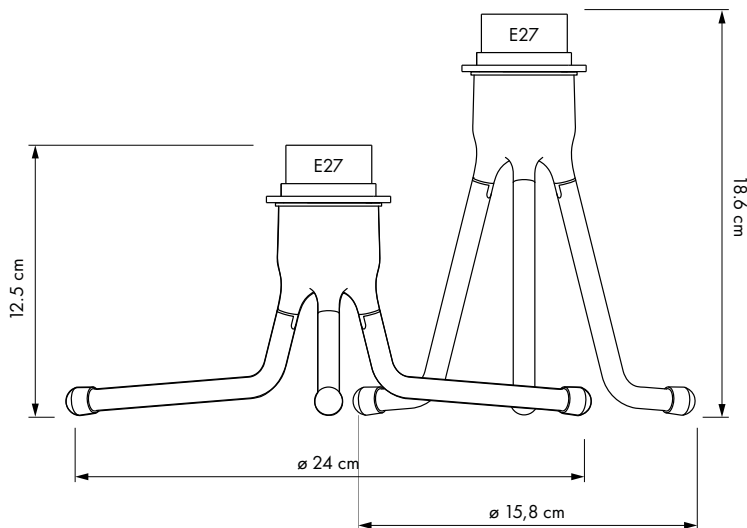









UMAGE Tripod base

#4053
#4054

Designed by Soren Ravn Christensen in Copenhagen, Denmark



	Dimensions ø 15,8 or 24 cm h 18,6 or 12,5 cm
	Material ABS, Aluminium
	Weight incl. packaging 610 g
	Light source E27 / E26 Max 15 W LED
	Packaging Gift Box, Dimensions (W×H×D): 16.6x16.6x9.3 cm
	Assembly time 5 min - video guide at umage.com
	Media Kit Photos, 3D models, 2D drawings Download at umage.com

#	Ordering Information	
	Tripod base white	#4053
	Tripod base black	#4054

Accessories		
	Idea 6W 60 mm LED bulb	#4026
	Idea 6W 80 mm LED bulb	#4033
	Idea 2W 45 mm LED bulb	#4039
	Idea 13W 70 mm LED bulb	#4136



Colour variations



 **Download the UIMAGE Unfold at Home App**
It helps you choose the perfect lamp

UNFOLD
AT HOME



UMAGE
Kongens Nytorv 15
DK-1050 Copenhagen K
Denmark

+45 31 39 31 31 (tel)
+45 31 73 32 29 (fax)
info@umage.com
www.umage.com

The specifications and dimensions are subject to change without notice
Document date: 23-05-2018